



element14

---

**EN** - For pricing and availability in your local country please visit one of the below links:

**DE** - Informationen zu Preisen und Verfügbarkeit in Ihrem Land erhalten Sie über die unten aufgeführten Links:

**FR** - Pour connaître les tarifs et la disponibilité dans votre pays, cliquez sur l'un des liens suivants:

[G2R-2-SND-DC24\(S\)](#)

**EN**

This Datasheet is presented by  
the manufacturer

**DE**

Dieses Datenblatt wird vom  
Hersteller bereitgestellt

**FR**

Cette fiche technique est  
présentée par le fabricant

# Power PCB Relay G2R

- Creepage distance of 8.0 mm (0.31) min. between coil and contact.
- Dual-winding latching type available.
- Plug-in and quick-connect terminals available.
- High sensitivity (360 mW) and high capacity (16 A) types available.
- Highly stable magnetic circuit for latching endurance and excellent resistance to vibration and shock.
- Safety-oriented design assuring high surge resistance: 10,000 V min. between coil and contacts.
- UL, CSA approved, marked with CE.

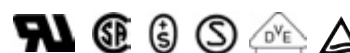
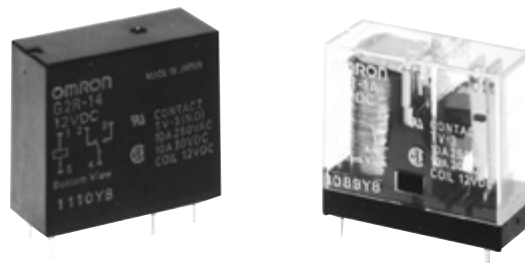

## Ordering Information

To order: Select the part number and add the desired coil voltage rating (e.g., G2R-14-DC12).

### ■ Non-Latching

#### 1-Pole - PCB Types

Type	Contact material	Contact form	Construction	Model
General purpose	AgCdO	SPDT	Semi-sealed	G2R-1
			Sealed	G2R-14
		SPST-NO	Semi-sealed	G2R-1A
			Sealed	G2R-1A4
High-capacity		SPDT	Semi-sealed	G2R-1-E
		SPST-NO		G2R-1A-E
High-sensitivity		SPDT	Semi-sealed	G2R-1-H
				Sealed
		SPST-NO	Semi-sealed	G2R-1A-H
			Sealed	G2R-1A4-H

#### 1-Pole - Plug-in/Quick-connect Types

Type	Contact material	Contact form	Terminal	Model
General purpose	AgCdO	SPDT	Plug-in	G2R-1-S
LED indicator				G2R-1-SN
Surge suppression diode				G2R-1-SD
LED indicator and surge suppression diode				G2R-1-SND
Upper-mount bracket		SPDT	Quick connect	G2R-1-T
		SPST-NO		G2R-1A-T

- Note:**
1. AgInSn and gold plated contacts available.
  2. Bifurcated button available.
  3. For individual product agency approvals consult factory.
  4. Class B coil insulation available.
  5. Push to test button available on plug-in type. Consult Omron for details.
  6. CE mark only on plug-in and quick connect types (G2R-□-S).

## 2-Pole - PCB Types

Type	Contact material	Contact form	Construction	Model
General purpose	AgCdO	DPDT	Semi-sealed	G2R-2
			Sealed	G2R-24
		DPST-NO	Semi-sealed	G2R-2A
			Sealed	G2R-2A4
High sensitivity	AgCdO	DPDT	Semi-sealed	G2R-2-H
			Sealed	G2R-24-H
		DPST-NO	Semi-sealed	G2R-2A-H
			Sealed	G2R-2A4-H

## 2 Pole - Plug-in/Quick-connect Types

Type	Contact material	Contact form	Terminal	Model
General purpose	AgCdO	DPDT	Plug-in	G2R-2-S
LED indicator				G2R-2-SN
Surge suppression diode				G2R-2-SD
Led indicator and surge suppression diode				G2R-2-SND

- Note:**
1. AgInSn and gold plated contacts available.
  2. Bifurcated button available.
  3. For individual product agency approvals consult factory.
  4. Class B coil insulation available.
  5. Push to test button available on plug-in type. Consult Omron for details.

## ■ Latching

Type	Contact form	Construction	Model
Dual coil latching	SPDT	Semi-sealed	G2RK-1
	SPST-NO		G2RK-1A
	DPDT		G2RK-2
	DPST-NO		G2RK-2A

## ■ Accessories

### Track Mounted Sockets/Track

Relay	Model	
	Socket	Mounting track
G2R-1-S□□ (1-pole)	P2RF-05	PFP-100N or
	P2RF-05-E	PFP-50N and
G2R-2-S□□ (2-pole)	P2RF-08	PFP-M end plate
	P2RF-08-E	PFP-S (optional spacer)

**Note:** “-E” models are of finger-safe product construction. Round terminals cannot be used. Use Y-shaped terminals.

### Screwless Clamp Terminal Socket Ordering Information

	1-pole	2-pole
Socket	P2RF-05-S	P2RF-08-S
Clip & release lever	P2CM-S	
Nameplate	R99-11 nameplate for MY	
Socket bridge	P2RM-SR, P2RM-SB	

**Note:** For complete specifications see the data sheet at Omron’s Knowledge center at [www.knowledge.omron.com](http://www.knowledge.omron.com).

## Back Connecting Sockets/Plate

Relay	Terminal	Model	
		Socket	Socket mounting plate
G2R-1-S□□ (1-pole)	Solder	P2R-05-A	P2R-P
	PC	P2R-05P	
G2R-2-S□□ (2-pole)	Solder	P2R-08A	
	PC	P2R-08P	

## Specifications

### ■ Contact Data

Non-latching general purpose, plug-in, plug-in operation indicator self-contained, plug-in diode self-contained and upper-mount bracket.

Load	1-pole type		2-pole type	
	Resistive load (p.f. = 1)	Inductive load (p.f. = 0.4) (L/R = 7 ms)	Resistive load (p.f. = 1)	Inductive load (p.f. = 0.4) (L/R = 7 ms)
Rated load	10 A at 250 VAC 10 A at 30 VDC	7.5 A at 250 VAC 5 A at 30 VDC	5 A at 250 VAC 5 A at 30 VDC	2 A at 250 VAC 3 A at 30 VDC
Contact material	AgCdO			
Carry current	10 A		5 A	
Max. operating voltage	380 VAC, 125 VDC			
Max. operating current	10 A		5 A	
Max. switching capacity	2,500 VA, 300 W	1,875 VA, 150 W	1,250 VA, 150 W	500 VA, 90 W
Min permissible load	100 mA, 5 VDC		10 mA, 5 VDC	

### Non-latching high capacity 1-pole type

Load	Resistive load (p.f. = 1)	Inductive load (p.f. = 0.4) (L/R = 7 ms)
Rated load	16 A at 250 VAC 16 A at 30 VDC	8 A at 250 VAC 8 A at 30 VDC
Contact material	AgCdO	
Carry current	16 A	
Max. operating voltage	380 VAC, 125 VDC	
Max. operating current	16 A	
Max. switching capacity	4,000 VA, 480 W	2,000 VA, 240 W
Min. permissible load	100 mA, 5 VDC	

### Non-latching high-sensitivity

Load	1-pole type		2-pole type	
	Resistive load (p.f. = 1)	Inductive load (p.f. = 0.4) (L/R = 7 ms)	Resistive load (p.f. = 1)	Inductive load (p.f. = 0.4) (L/R = 7 ms)
Rated load	5 A at 250 VAC 5 A at 30 VDC	2 A at 250 VAC 3 A at 30 VDC	3 A at 250 VAC 3 A at 30 VDC	1 A at 250 VAC 1.50 A at 30 VDC
Contact material	AgCdO			
Carry current	5 A		3 A	
Max. operating voltage	380 VAC, 125 VDC			
Max. operating current	5 A		3 A	
Max. switching capacity	1,250 VA, 150 W	500 VA, 90 W	750 VA, 90 W	250 VA, 45 W
Min permissible load	100 mA, 5 VDC		10 mA, 5 VDC	

Latching

Load	1-pole type		2-pole type	
	Resistive load (p.f. = 1)	Inductive load (p.f. = 0.4) (L/R = 7 ms)	Resistive load (p.f. = 1)	Inductive load (p.f. = 0.4) (L/R = 7 ms)
Rated load	5 A at 250 VAC 5 A at 30 VDC	3.50 A at 250 VAC 2.50 A at 30 VDC	3 A at 250 VAC 3 A at 30 VDC	1.50 A at 250 VAC 2 A at 30 VDC
Contact material	AgCdO			
Carry current	5 A		3 A	
Max. operating voltage	380 VAC, 125 VDC			
Max. operating current	5 A		3 A	
Max. switching capacity	1,250 VA, 150 W	875 VA, 75 W	750 VA, 90 W	375 VA, 60 W
Min permissible load	100 mA, 5 VDC		10 mA, 5 VDC	

- Note: 1. P standard:  $\lambda_{50} = 0.10 \times 10^{-6}$  operation.  
 2. AgInSn contacts available.  
 3. For individual product agency approvals consult factory.

■ Coil Data

Non-latching DC coil

Rated voltage (VDC)	Rated current (mA)	Coil resistance ( $\Omega$ )	Coil inductance (ref. value) (H)		Pick-up voltage	Dropout voltage	Maximum voltage	Power consumption (mW)
			Armature OFF	Armature ON				
3	176	17	0.07	0.14	70% max.	15% min.	110% max. at 70°C (158°F)	Approx. 530
5	106	47	0.20	0.39				
6	88.20	68	0.28	0.55				
12	43.60	275	1.15	2.29				
24	21.80	1,100	4.27	8.55				
48	11.50	4,170	13.86	22.71				
100	5.30	18,860	67.20	93.20				
110	4.80	22,900	81.50	110.60				

Non-latching AC coil

Rated voltage (VDC)	Rated current (mA)	Coil resistance ( $\Omega$ )	Coil inductance (ref. value) (H)		Pick-up voltage	Dropout voltage	Maximum voltage	Power consumption (mW)
			Armature OFF	Armature ON				
6	150	16	0.05	0.10	80% max.	30% min.	110% max. at 70°C (158°F)	Approx. 0.9
12	75	65	0.19	0.39				
24	37.50	260	0.81	1.55				
50	18	1,130	3.25	6.73				
110	10.60	4,600	13.34	26.84				
120	7.50	6,500	21	42				
220	5.30	22,000	51.30	102				
240	3.80	30,000	65.50	131				

Non-latching high-sensitivity DC coil

Rated voltage (VDC)	Rated current (mA)	Coil resistance ( $\Omega$ )	Coil inductance (ref. value) (H)		Pick-up voltage	Dropout voltage	Maximum voltage	Power consumption (mW)
			Armature OFF	Armature ON				
3	120	25	0.13	0.26	70% max.	15% min.	110% max. at 70°C (158°F)	Approx. 360
5	71.40	70	0.37	0.75				
6	60	100	0.63	1.07				
12	30	400	2.14	4.27				
24	15	1,600	7.80	15.60				
48	7.50	6,400	31.20	62.40				

Latching dual coil type - Set coil

Rated voltage (VDC)	Rated current (mA)	Coil resistance (Ω)	Coil inductance (ref. value) (H)		Pick-up voltage	Dropout voltage	Maximum voltage	Power consumption (mW)
			Armature OFF	Armature ON				
3	227	10.80	0.026	0.052	70% max.	70% max.	110% max. at 70°C (158°F)	Approx. 850
5	167	30	0.073	0.146				
6	138	43.50	0.104	0.208				
12	70.60	170	0.42	0.83				
24	34.60	694	1.74	3.43				

Latching dual coil type - Reset coil

Rated voltage (VDC)	Rated current (mA)	Coil resistance (Ω)	Coil inductance (ref. value) (H)		Pick-up voltage	Dropout voltage	Maximum voltage	Power consumption (mW)
			Armature OFF	Armature ON				
3	200	15	0.001	0.002	70% max.	70% max.	110% max. at 70°C (158°F)	Approx. 600
5	119	42	0.003	0.006				
6	100	60	0.005	0.009				
12	50	240	0.018	0.036				
24	25	960	0.079	0.148				

**Note:** 1. The rated current and coil resistance are measured at a coil temperature of 23°C (73°F) with a tolerance of ±10%.  
 2. The operating characteristics are measured at a coil temperature of 23°C (73°F).

■ Characteristics

Item	Non-latching		Latching	
Contact resistance	100 mΩ			
Operate (set) time	15 ms. max.		20 ms max.	
Release (reset) time	AC: 10 ms max.; DC: 5 ms max.		20 ms max.	
Bounce time	Operate	---	Mean value approx. 3 ms	
	Release	---	Mean value approx. 8 ms	
Operating frequency	Mechanical	18,000 operations/hour		
	Electrical	1,800 operations/hour (under rated load)		
Insulation resistance	1,000 MΩ min. (at 500 VDC)			
Dielectric strength	5,000 VAC, 50/60 Hz for 1 minute between coil and contacts			
	1,000 VAC, 50/60 Hz for 1 minute across contacts of same pole			
	3,000 VAC, 50/60 Hz for 1 minute between contact sets, 2-pole non-latching			
	1,000 VAC, 50/60 Hz for 1 minute between set and reset coils of dual coil latching			
Vibration	Mechanical durability	10 to 55 Hz; 1.50 mm (0.06) double amplitude		
	Malfunction durability	10 to 55 Hz; 1.50 mm (0.06) double amplitude		
Shock	Mechanical durability	1,000 m/s <sup>2</sup> (approx. 100G)		
	Malfunction durability	200 m/s <sup>2</sup> (approx. 20 G) when energized 100 m/s <sup>2</sup> (approx. 10 G) when de-energized	500 m/s <sup>2</sup> (approx. 50 G) at set 100 m/s <sup>2</sup> (approx. 10 G) at reset	
Ambient temperature	-40 to 70°C (-40 to 158°F)			
Humidity	35% to 85% RH			
Service life	Mechanical	AC: 10,000,000 operations min. DC: 20,000,000 operations min. (at 18,000 operations/hour)		10,000,000 operations min. (at 18,000 operations/hour)
	Electrical	See "Characteristics Data"		
Weight	Approx. 17 g (0.60 oz.)		Approx. 17 g (0.60 oz.)	

**Note:** Data shown are of initial value.

## ■ Characteristic Data

### Maximum Switching Capacity - Non-latching Types

PCB: Single-pole general purpose  
Semi-sealed

Plug-in: Single-pole single button  
Quick-connect

High capacity

PCB: Single-pole high sensitivity  
Two-pole general purpose  
Plug-in: Two-pole single button

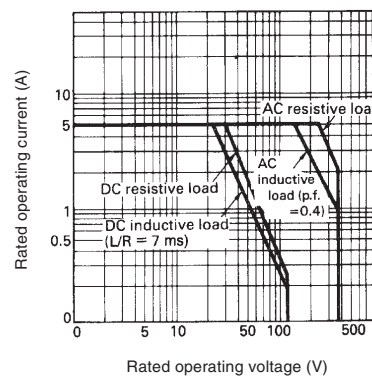
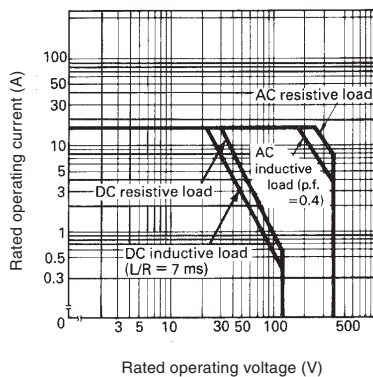
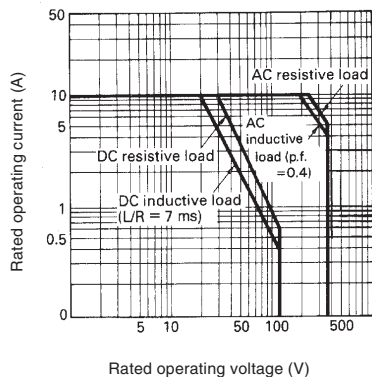

PCB: Two-pole high sensitivity

PCB: Single-pole general purpose  
Sealed

PCB: Two-pole general purpose  
Sealed

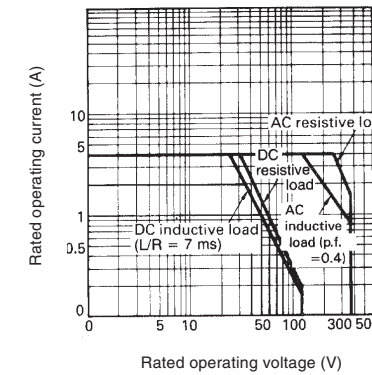
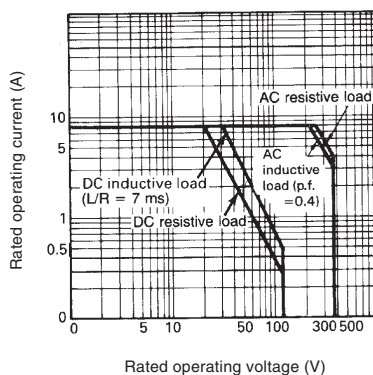
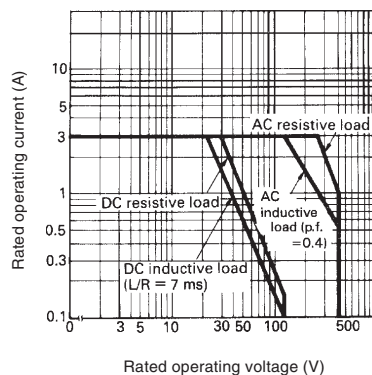

### Electrical Service Life - Non-latching Types

PCB: Single-pole general purpose  
Semi-sealed

High capacity

PCB: Single-pole high sensitivity  
Two-pole general purpose  
Plug-in: Two-pole single button

Plug-in: Single-pole single button  
Quick connect

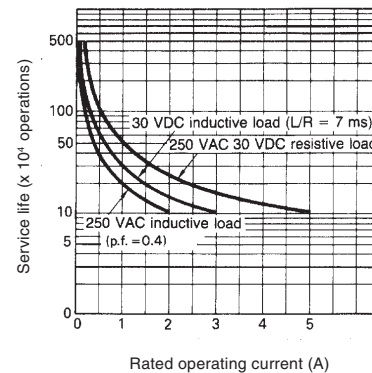
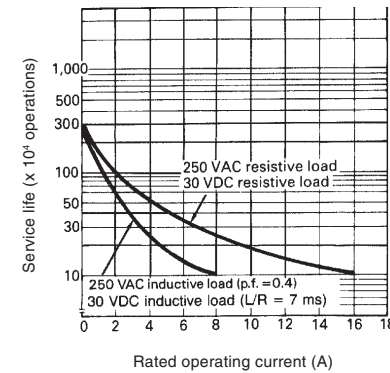
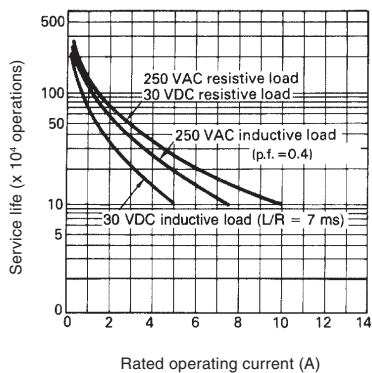

PCB: Two-pole high sensitivity

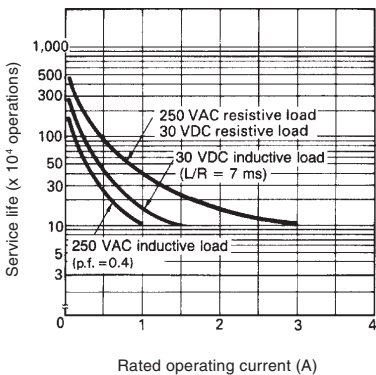

PCB: Single-pole general purpose Sealed

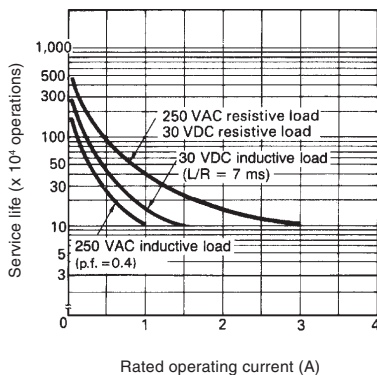

PCB: Two-pole general purpose Sealed

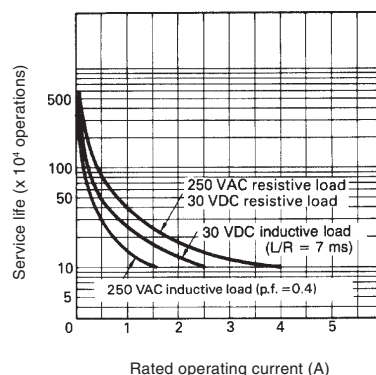

## Maximum Switching Capacity - Latching Types

One pole

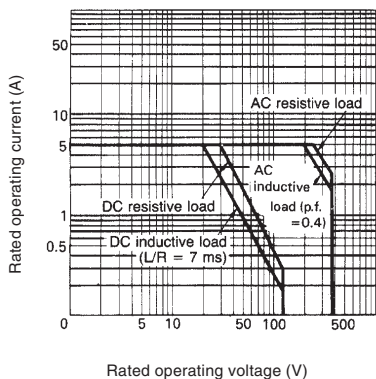

Two-pole

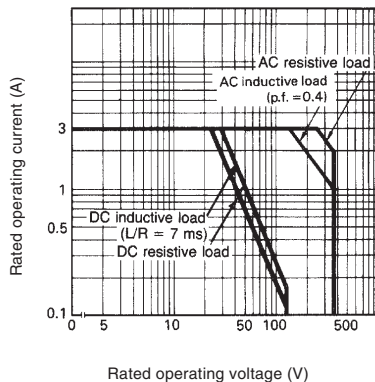

## Electrical Service Life - Latching Types

One pole

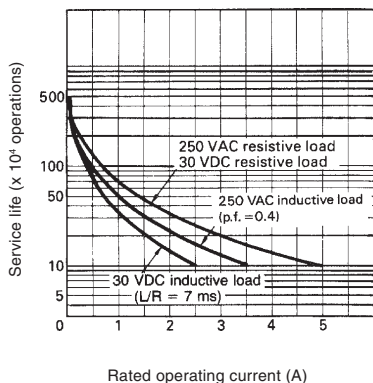

Two-pole

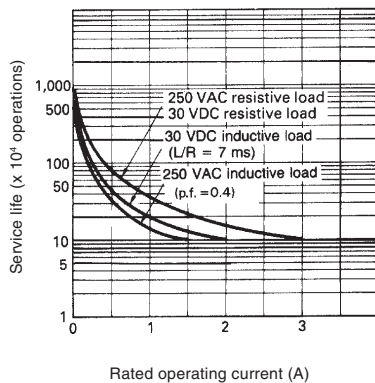



# Dimensions

Unit: mm (inch)

## ■ Non-latching

PCB Terminal: SPDT, general purpose & high sensitivity

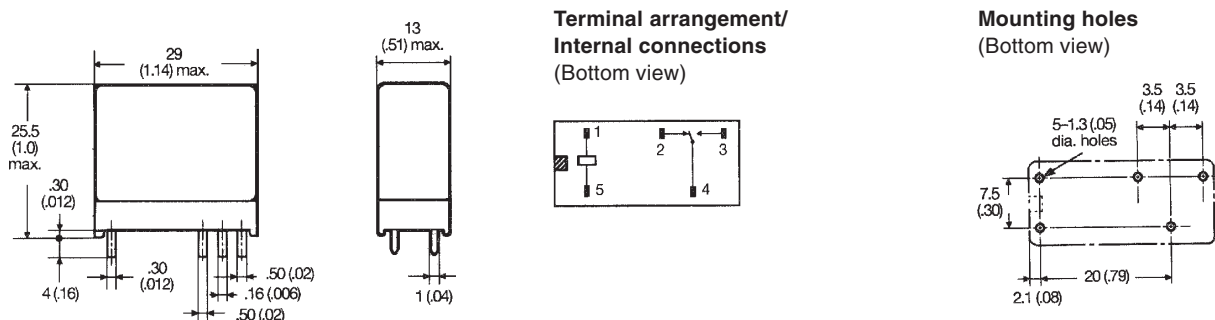

PCB Terminal: SPST-NO, general purpose & high sensitivity

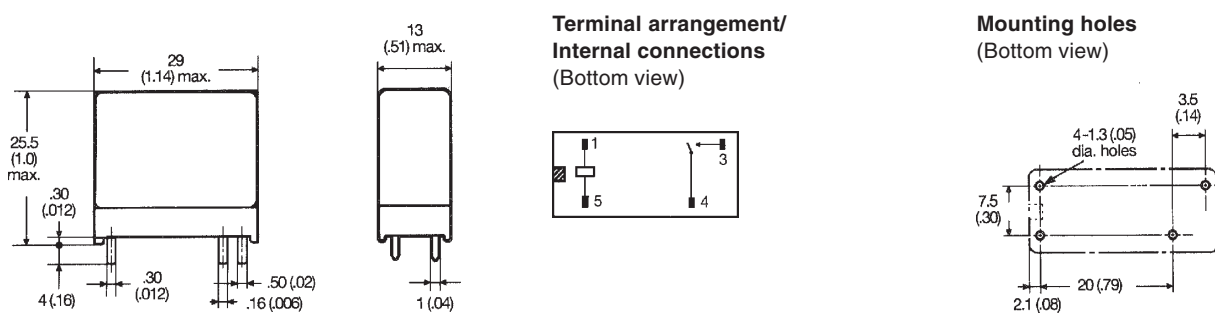

PCB Terminal: SPDT, high capacity

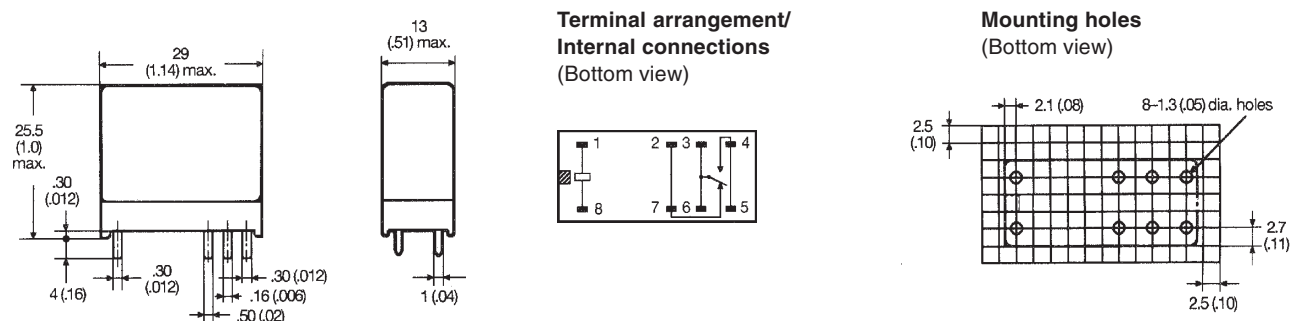

PCB Terminal: SPST-NO, high capacity

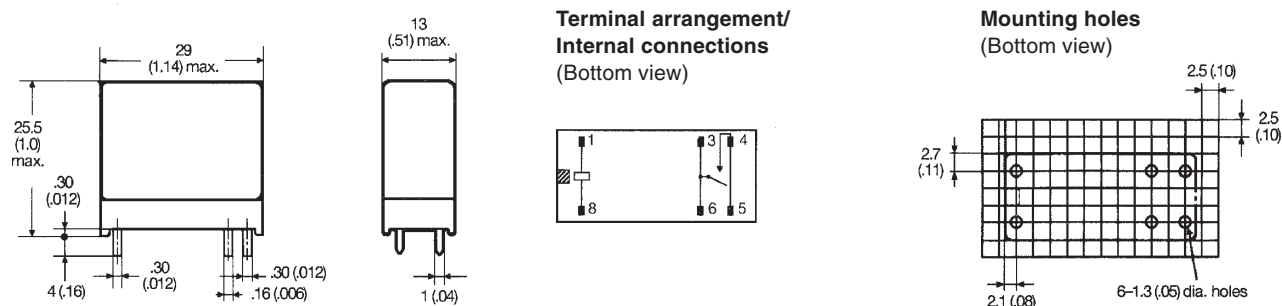

- Note: 1. and indicate mounting orientation marks.  
 2. A tolerance of  $\pm 0.10$  (0.004) applies to the above dimensions.

Plug-in: SPDT, single button general purpose, LED indicator, surge suppression diode

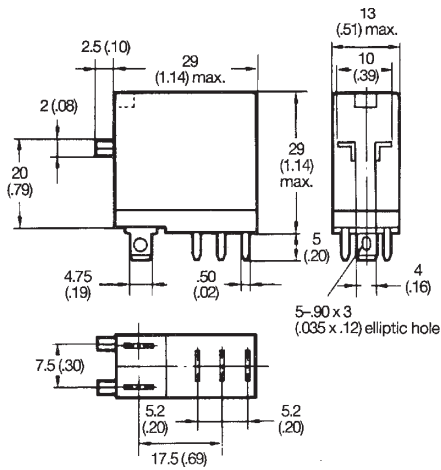

Terminal arrangement/Internal connections  
(Bottom view)

G2R-1-S

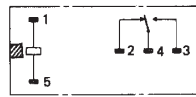

G2R-1-SN(AC)

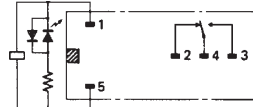

G2R-1-SND(DC)

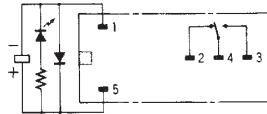

G2R-1-SN(DC)

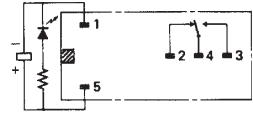

G2R-1-SD(DC)

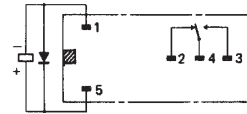

Quick-connect: SPDT

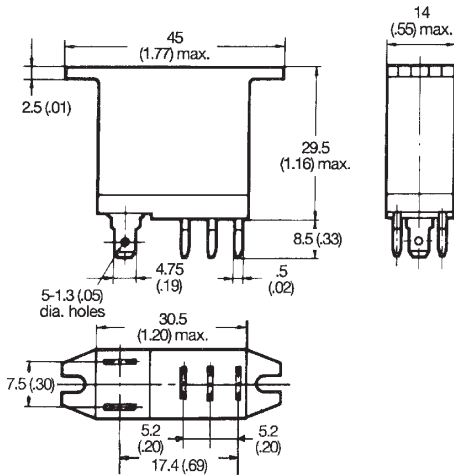

Terminal arrangement/  
Internal connections  
(Bottom view)

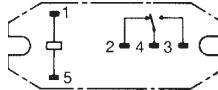

Mounting holes  
(Bottom view)

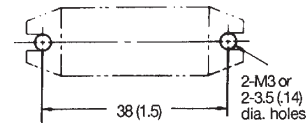

Quick-connect: SPST-NO

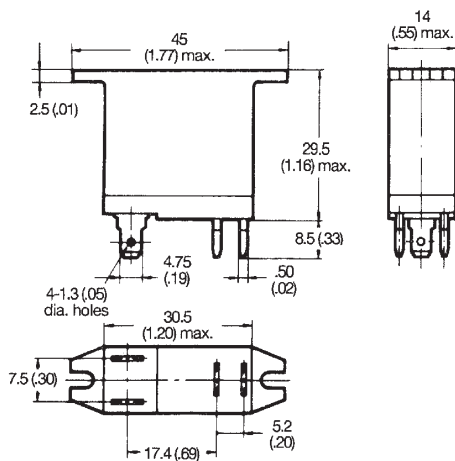

Terminal arrangement/  
Internal connections  
(Bottom view)

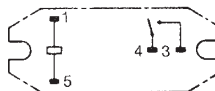

Mounting holes  
(Bottom view)

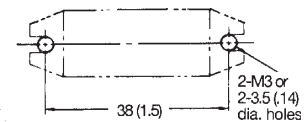

Note: 1. and indicate mounting orientation marks.  
2. A tolerance of  $\pm 0.10$  (0.004) applies to the above dimensions

**PCB Terminal: DPDT, general purpose & high sensitivity**

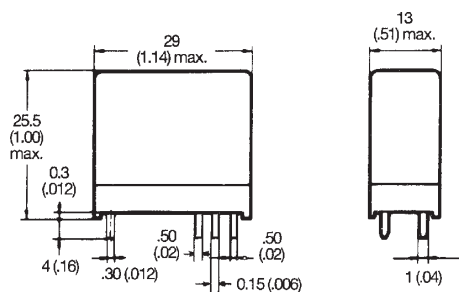

**Terminal arrangement/  
Internal connections**  
(Bottom view)

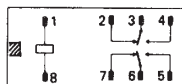

**Mounting holes**  
(Bottom view)

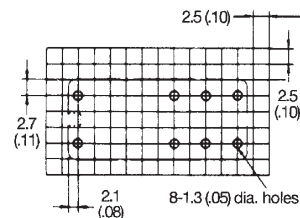

**PCB Terminal: DPST-NO, general purpose & high sensitivity**

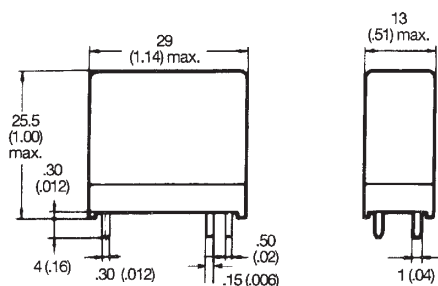

**Terminal arrangement/  
Internal connections**  
(Bottom view)

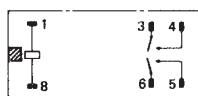

**Mounting holes**  
(Bottom view)

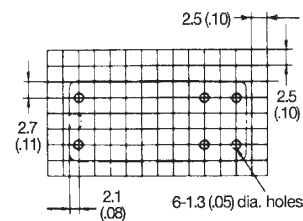

**Plug-in: DPDT**

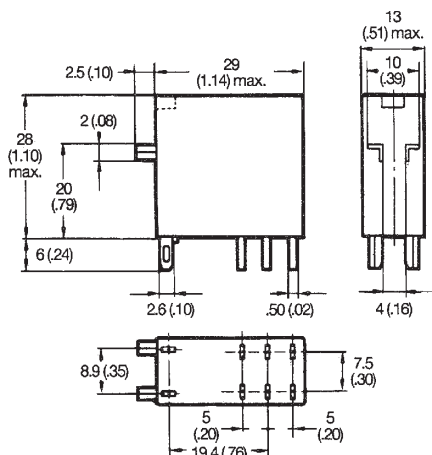

**Terminal arrangement/Internal connections**  
(Bottom view)

**G2R-2-S**

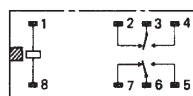

**G2R-2-SN(AC)**

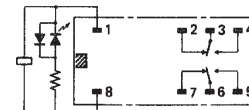

**G2R-2-SND(DC)**

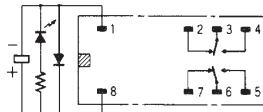

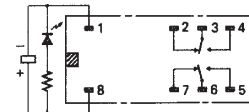

**G2R-2-SN(DC)**

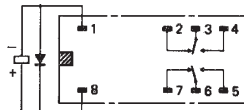

**G2R-2-SD(DC)**



- Note:** 1.  and  indicate mounting orientation marks.  
2. A tolerance of  $\pm 0.10$  (0.004) applies to the above dimensions.

# ■ Latching

## SPDT, Dual coil latching G2RK-1

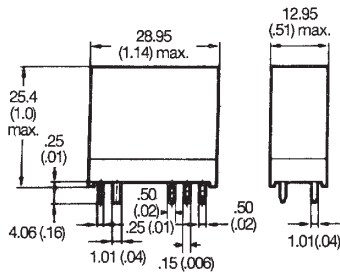

Dual coil

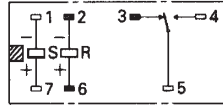

Dual coil

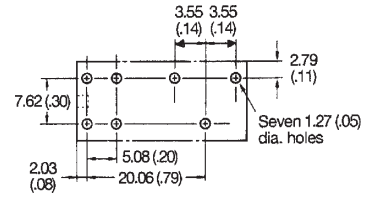

## SPST-NO, Dual coil latching G2RK-1A

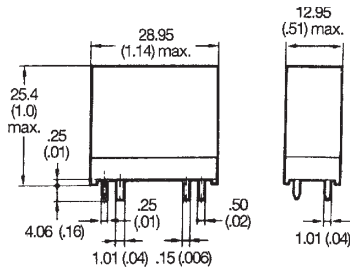

Dual coil

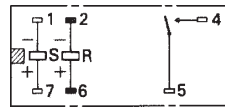

Dual coil

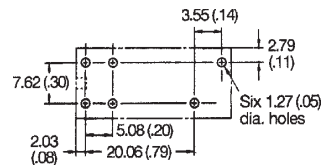

## DPDT, Dual coil latching G2RK-2

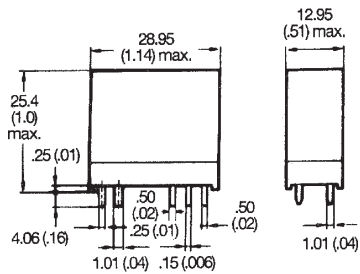

Dual coil

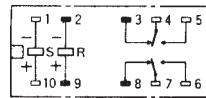

Dual coil

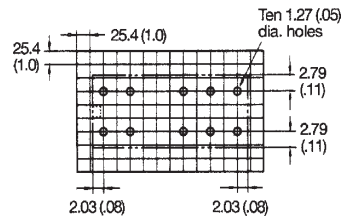

## DPST-NO, Dual coil latching G2RK-2A

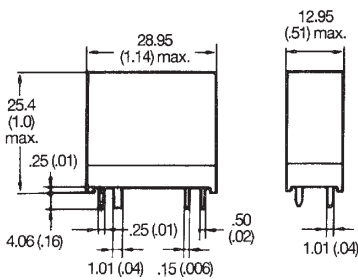

Dual coil

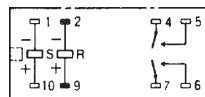

Dual coil

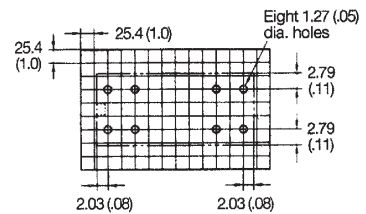

- Note: 1. and indicate mounting orientation marks.  
2. A tolerance of  $\pm 0.10$  (0.004) applies to the above dimensions.

## Accessories

### Track mounted socket P2RF-05 (UL E87929/CSA LR31928)

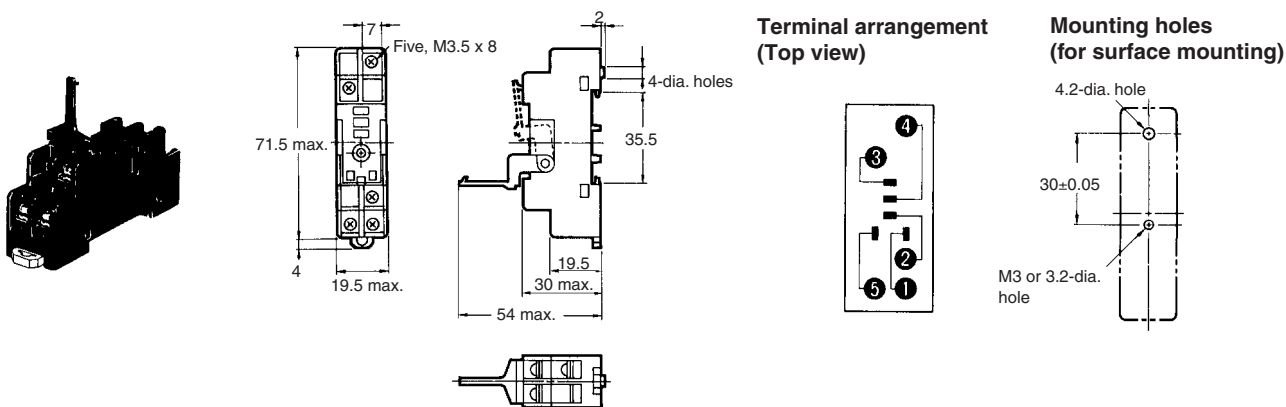

### Track mounted socket P2RF-05-E (UL E87929/CSA LR31928)

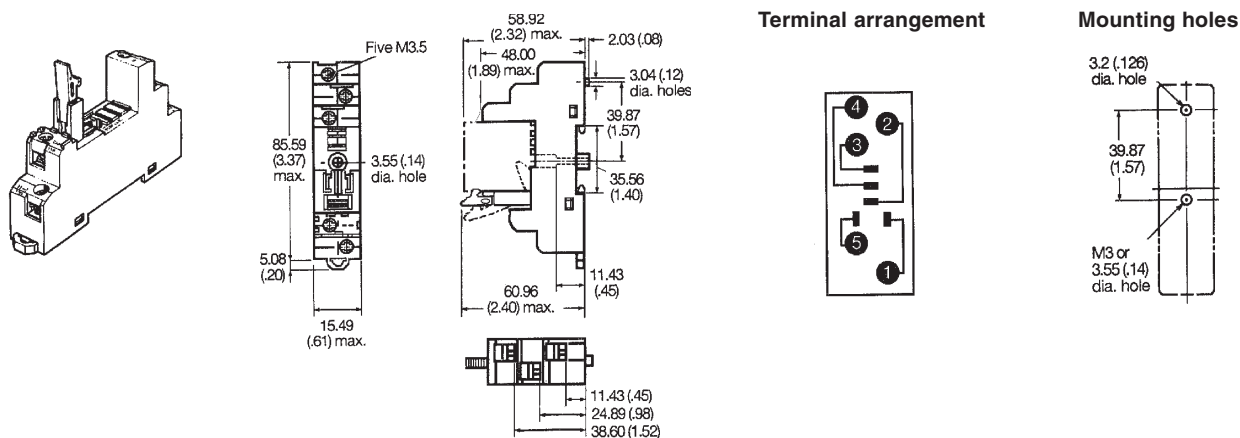

### Track mounted socket P2RF-08 (UL E87929/CSA LR31928)

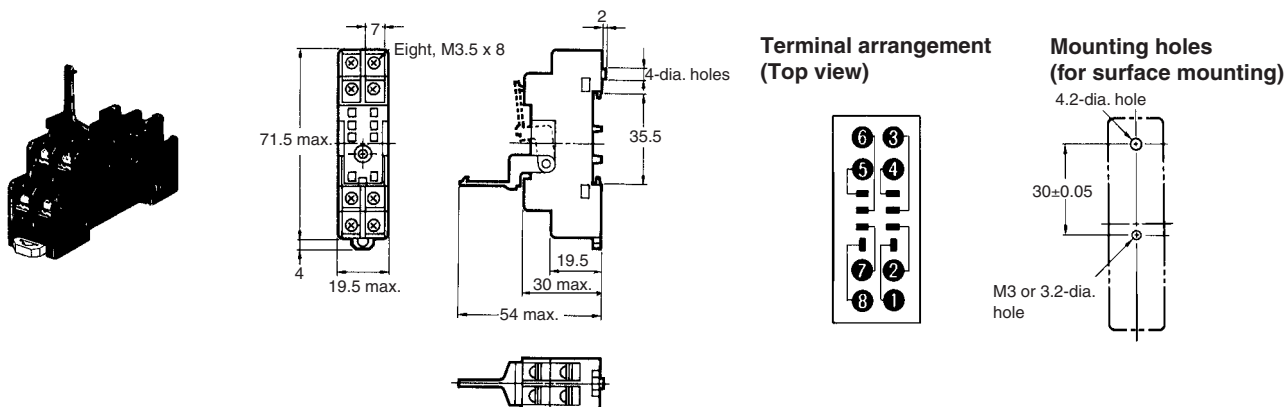

- Note:** 1. and indicate mounting orientation marks.  
2. A tolerance of ±0.10 (0.004) applies to the above dimensions.

**Track mounted socket**  
**P2RF-08-E (UL E87929/CSA LR31928)**

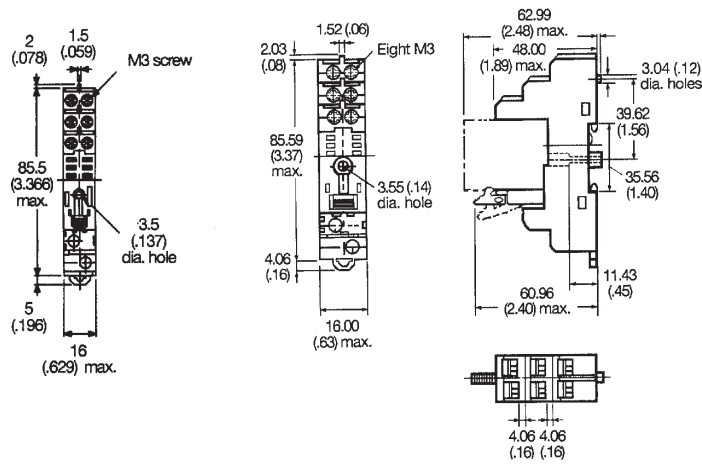

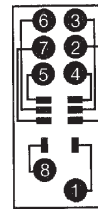

**Terminal arrangement**

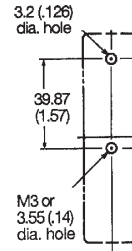

**Mounting holes**



- Note:** 1.  and  indicate mounting orientation marks.  
 2. A tolerance of  $\pm 0.10$  (0.004) applies to the above dimensions.

**Screwless Clamp Terminal Socket  
P2RF-05-S (UL E8729/CSA LR31928)**

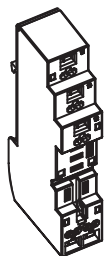

Standard Model

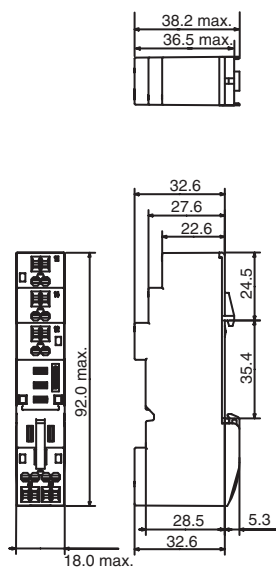

**Terminal Arrangement**

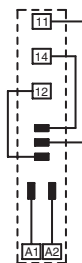

**Mounting Height (with lever)**

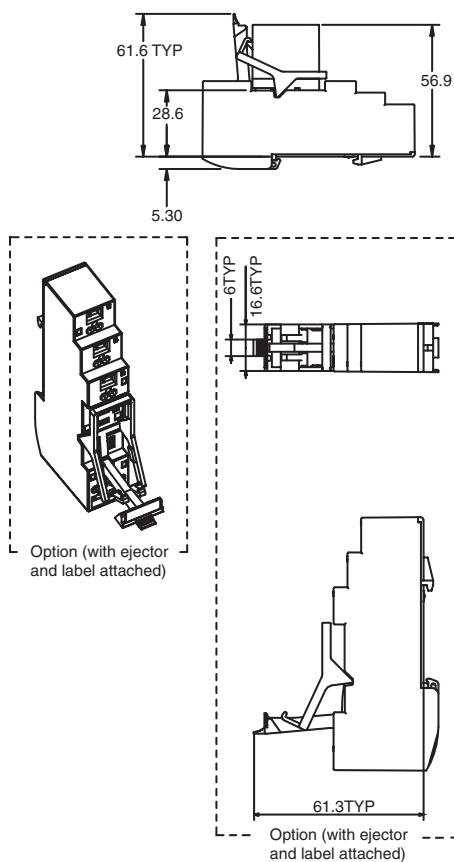

**Screwless Clamp Terminal Socket  
P2RF-08-S (UL E8729/CSA LR31928)**

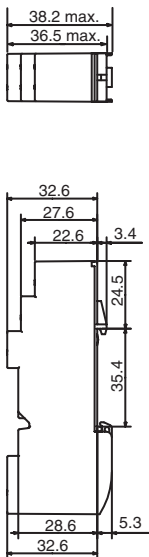
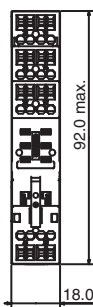
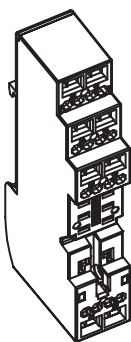

**Terminal Arrangement**

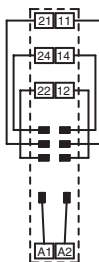

**Mounting Height (with lever)**

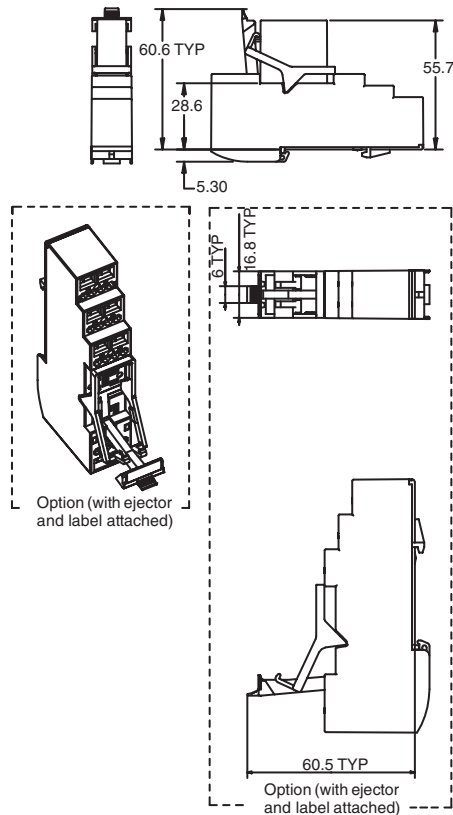

**Socket**

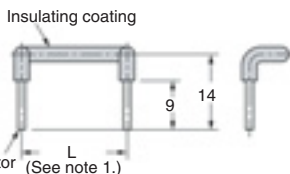

**Note: 1.** The relationship between the model, the length L, and the color of the insulating coating is shown in the following table.

Model	Length (L) mm	Color of insulating coating
P2RM-SR	14.3	Red
P2RM-SB		Blue

- 2. The insulating coating must be able to withstand a voltage of 3,000 V for 1 minute. Use either PE or PA as the material of the insulating coating.
- 3. The positions of the ends of the insulating coating must not vary more than 0.5 mm.

4. The characteristics of the socket bridge are shown in the following table.

Item	Characteristic
Rated ON current	10 A
Rated insulation voltage	250 VAC
Temperature rise	35°C max.
Dielectric strength	3,000 VAC for 1 minute
Ambient operating temperature	-55 to 70°C

**Clip and Release Lever**

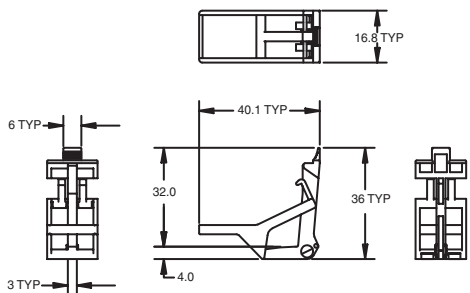

**Back connecting socket  
P2R-05P (1-pole) (UL E87929/CSA LR31928)**

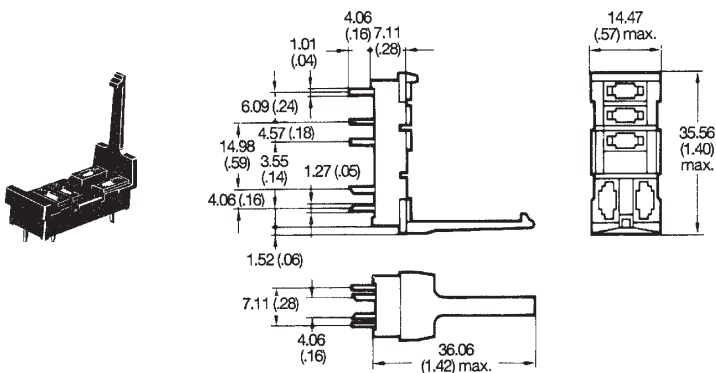

**Terminal arrangement**

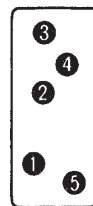

**Mounting holes**

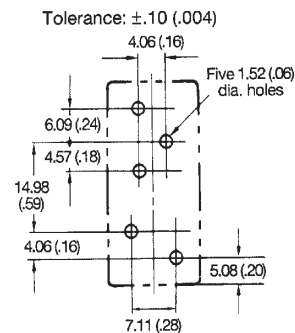

- Note: 1.** [Hatched box] and [Empty box] indicate mounting orientation marks.
- 2. A tolerance of ±0.10 (0.004) applies to the above dimensions.



**Back connecting socket  
P2R-08P (2-pole) (UL E87929/CSA LR31928)**

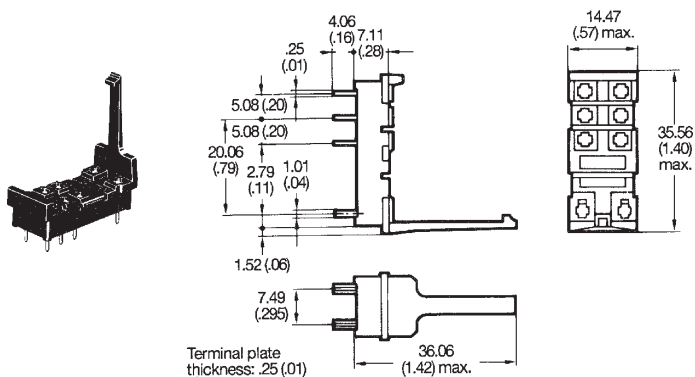

**Terminal arrangement**



**Mounting holes**

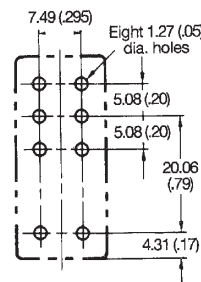

**Back connecting socket  
P2R-05A (1-pole) (UL E87929/CSA LR31928)**

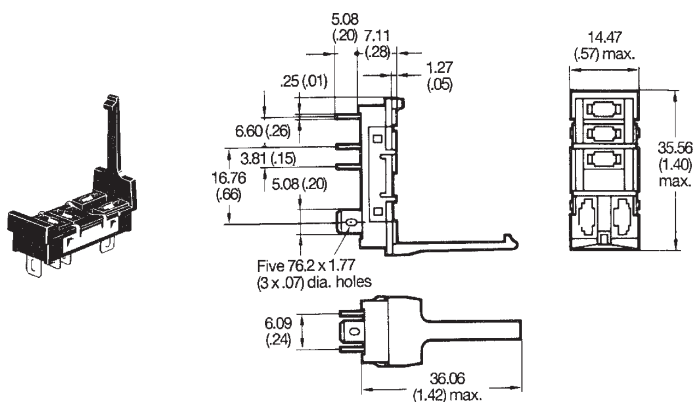

**Terminal arrangement**



**Mounting holes  
(Bottom view)**

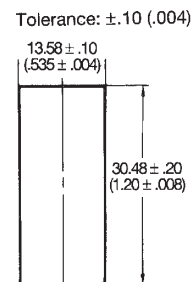

Recommended thickness of the panel is 1.52 (.06) to 2.03 (.08)

**Back connecting socket  
P2R-08A (2-pole) (UL E87929/CSA LR31928)**

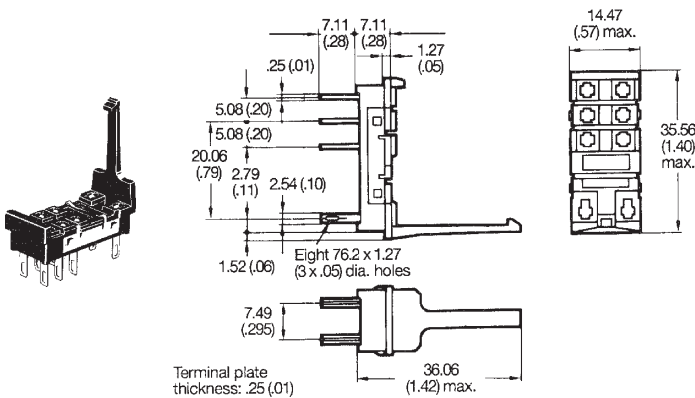

**Terminal arrangement**

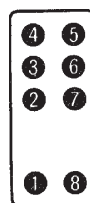

**Mounting holes  
(Bottom view)**

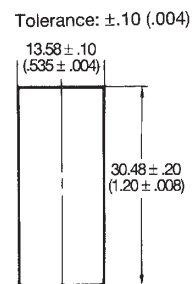

Recommended thickness of the panel is 1.52 (.06) to 2.03 (.08)

**Note:** 1. and indicate mounting orientation marks.  
2. A tolerance of ±0.10 (0.004) applies to the above dimensions.



## ■ Approvals

UL (File No. E41643)/ CSA (File No. 31928)

Type	Contact form	Coil rating	Contact ratings
G2R-1 G2R-14 G2R-1-H G2R-14-H G2R-1-S G2R-1-T	SPDT	3 to 110 VDC 3 to 240 VDC	10 A, 30 VDC (Resistive) 10 A, 250 VAC (General purpose) 10 A, 277 VAC (General purpose) TV-3, 120 VAC (NO contact) 360 WT, 120 VAC (Tungsten) 1/3 HP, 125 VAC (NO contact) 1/2 HP, 250 VAC (NO contact) 1/2 HP, 277 VAC (NO contact) TV-8, 120 VAC (NO contact, ASI contacts) B300 (Pilot duty)
G2R-1A G2R-1A4 G2R-1A-H G2R-1A4-H G2R-1A-T	SPST-NO		
G2R-1-E	SPDT	3 to 110 VDC 3 to 240 VAC	20 A, 277 VAC (General purpose) 16 A, 30 VDC (Resistive) 16 A, 250 VAC (General purpose) 360 WT, 120 VAC (Tungsten) TV-3, 120 VAC (NO contact) 1/2 HP, 240 VAC 1 HP, 240 VAC TV-8, 120 VAC (No contact, ASI contacts)
G2R-1A-E	SPST-NO		
G2R-2 G2R-24 G2R-2-H G2R-24-H G2R-2-S G2R-2-A G2R-2A4 G2R-2A-H G2R-2A4-H	DPDT	3 to 110 VDC 3 to 240 VAC	10 A, 30 VDC (Resistive) 10 A, 277 VAC (General purpose) 5 A, 250 VAC (General purpose) TV-3, 120 VAC (NO contact) 1/6 HP, 120 VAC 1/3 HP, 240 VAC 1/3 HP, 265 VAC 250 VA, 120 VAC (Pilot duty) B300 (Pilot duty)
G2RK-1	SPDT	3 to 24 VDC	10 A, 30 VDC (Resistive)
G2RK-1A	SPST-NO		10 A, 250 VAC (General purpose) TV-3 (NO contact) 1/6 HP, 120 VAC 1/2 HP, 120 VAC A300 (Pilot duty)
G2RK-2	DPDT	3 to 24 VDC	5 A, 30 VDC (Resistive)
G2RK-2A	DPST-NO		5 A, 250 VAC (General purpose) TV-3 (NO contact) 1/6 HP, 120 VAC 1/3 HP, 240 VAC

**Note:** 1. The rated values approved by each of the safety standards (e.g., UL and CSA) may be different from the performance characteristics individually defined in this catalog.

2. In the interest of product improvement, specifications are subject to change.

ALL DIMENSIONS SHOWN ARE IN MILLIMETERS. To convert millimeters into inches, divide by 25.4

**OMRON**

**OMRON ELECTRONICS LLC**

One Commerce Drive  
Schaumburg, IL 60173

**847-882-2288**

**OMRON CANADA, INC.**

885 Milner Avenue  
Toronto, Ontario M1B 5V8

**416-286-6465**

**OMRON ON-LINE**

Global - <http://www.omron.com>  
USA - <http://www.omron.com/oei>  
Canada - <http://www.omron.ca>



element14

---

**EN** - For pricing and availability in your local country please visit one of the below links:

**DE** - Informationen zu Preisen und Verfügbarkeit in Ihrem Land erhalten Sie über die unten aufgeführten Links:

**FR** - Pour connaître les tarifs et la disponibilité dans votre pays, cliquez sur l'un des liens suivants:

[G2R-2-SND-DC24\(S\)](#)

**EN**  
This Datasheet is presented by  
the manufacturer

**DE**  
Dieses Datenblatt wird vom  
Hersteller bereitgestellt

**FR**  
Cette fiche technique est  
présentée par le fabricant